

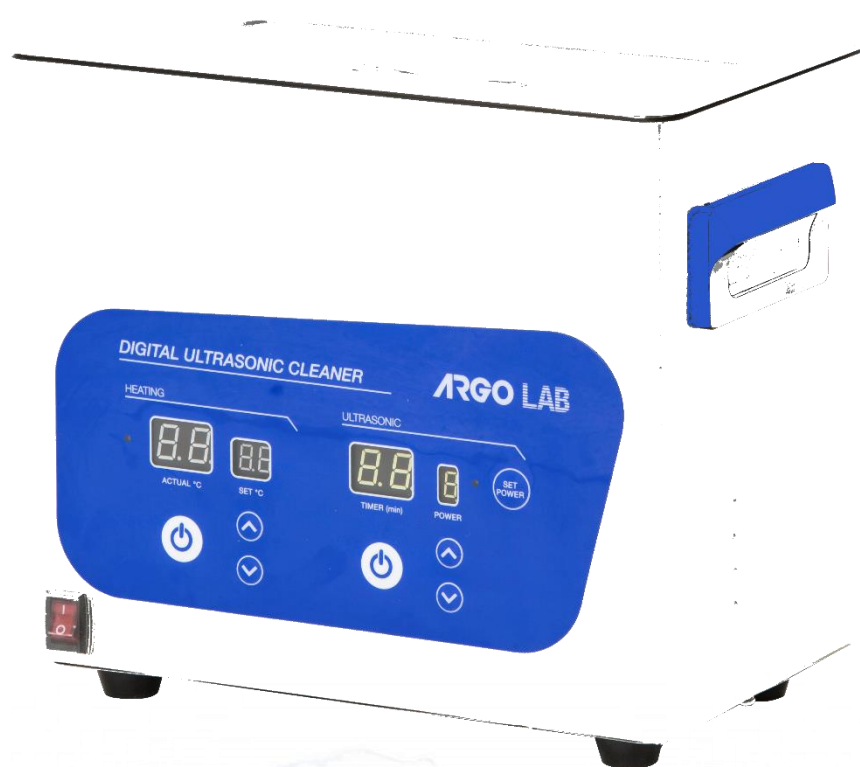

Ultrasonic Cleaner Baths

DU SERIES Manual



ARGO LAB





Index

Page 2 Introduction
 Page 2 Warning
 Page 3 Description DU-32, DU-45, DU-65 AND DU-100
 Page 3 Operating instructions
 Page 4 Application
 Page 5 Specification
 Page 5 Cleaning process
 Page 6 Maintenance / Care
 Page 6 Disposal of electronic devices
 Page 7 Description DU-06

PACK CONTENTS

<p>Ultrasonic bath</p>	<p>Lid</p>	<p>Basket</p>
<p>Mucasol®</p>		
<p>65ml universal cleaning solution</p>	<p>Power cable</p>	<p>Instruction manual</p>



INTRODUCTION

Ultrasonic cleaner is based on the cavitation effect caused by high frequency ultrasonic wave vibration signal in fluid. Microscopic bubbles are formed and they implode violently that cause cavitation, which gives out great impact of the cleaning subject and provides an intense scrubbing action on the surface of cleaning subject. Additionally, the bubbles are small enough to penetrate even microscopic crevices, cleaning them thoroughly and consistently.

SAFETY WARNINGS

Observe and follow the operation manual

	<p>This instrument has been designed for the ultrasonic treatment of <u>items</u> in <u>liquids</u> only. Don't operate without liquids. This product must be operated by qualified staff only.</p>
	<p>Connect the unit to a grounded shockproof socket only! Do not open the unit! Maintenance must be done by authorised personnel only! Use this product in a stable and dry work place! Use only distilled water! Pull the mains plug in case of any malfunctions!</p>
	<p>Do not operate the unit with flammable cleaning media!</p>
	<p>Do not put any acids or chlorides into the stainless-steel tank! Do not place any items directly on the tank floor, but use the basket!</p>
	<p>Do not reach inside the cleaning liquid or touch sound carrying parts (tank, basket, cleaning items, etc.) during operation.</p>
	<p>Ultrasonic cleaner unit can produce annoying sound.</p>
	<p>Exclusion of liability; the manufacturer cannot be held liable for damages on persons, equipment or cleaning items caused by improper use and non-observance of the Operating Instructions. The operator is responsible for the instructions of the operating staff. For any queries please contact your supplier or the manufacturer</p>



DESCRIPTION

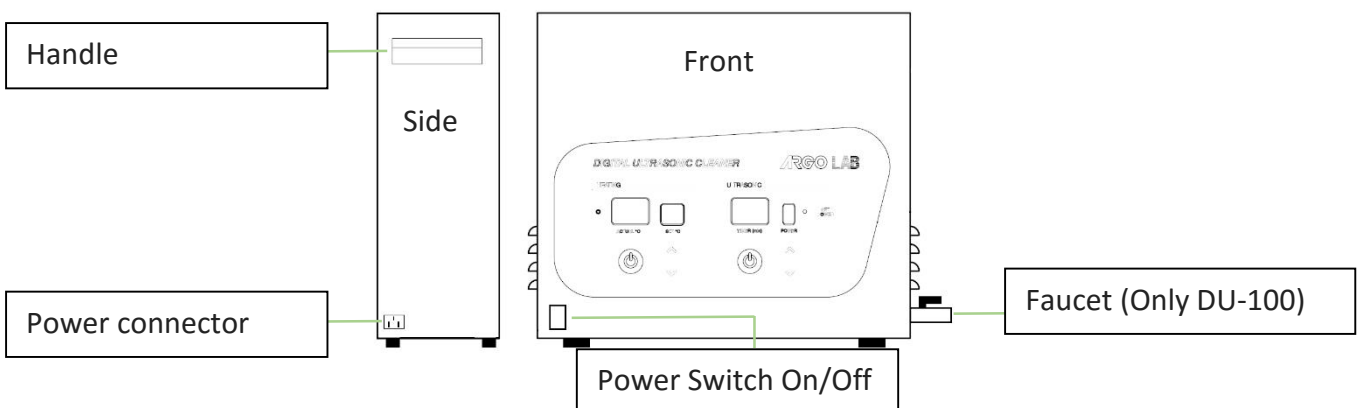
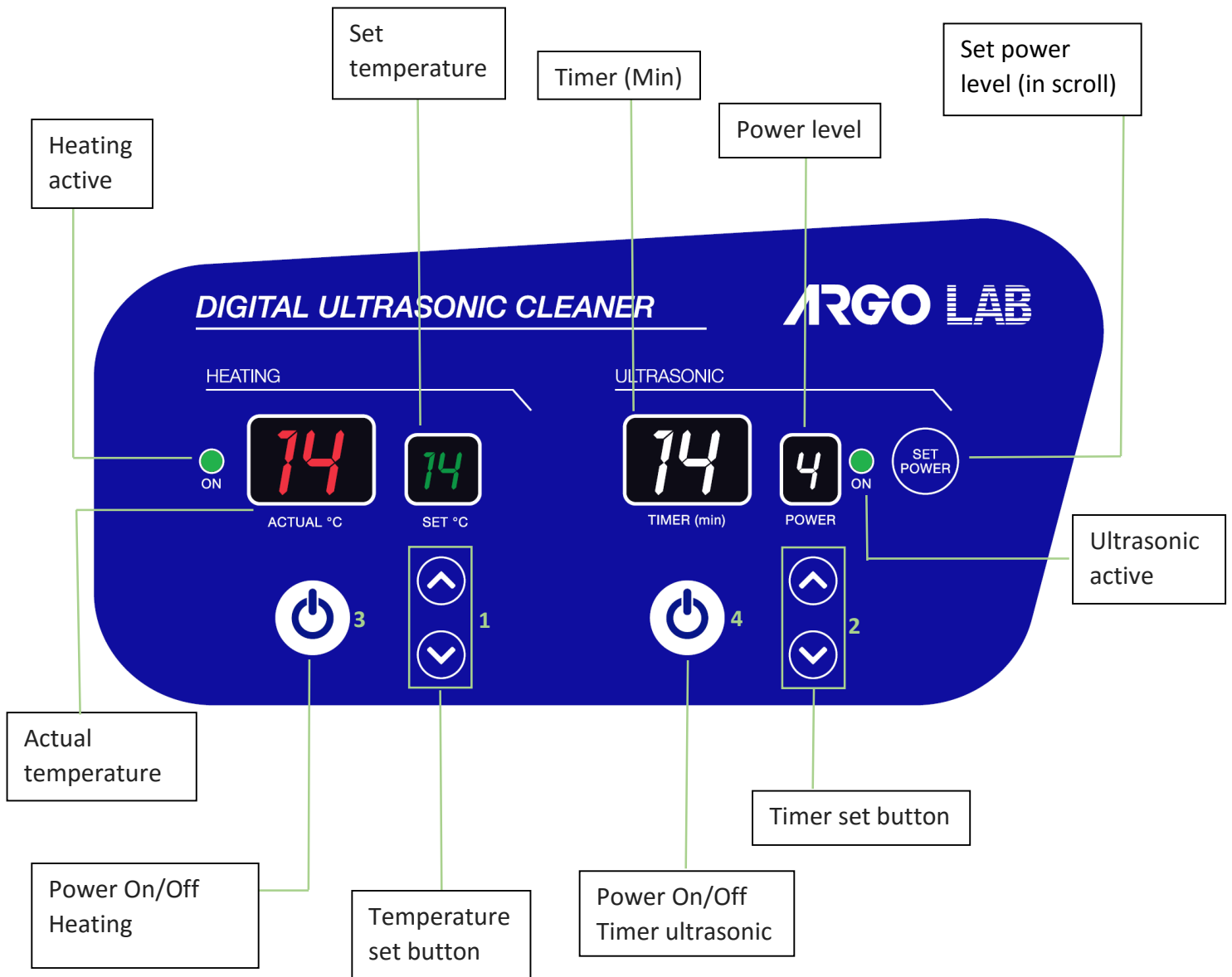

DU-32, DU-45, DU-65 AND DU-100







OPERATING INSTRUCTIONS

Setting temperature

1. Press the button  (1) to increase or  (1) the button to decrease the desired temperature, the “SET °C” windows shows the setting temperature. Press the heating power button  (3) to start and stop the heating function. While heating is occurring, the green “HEATING” light will illuminate.

Setting timer

1. Press the button  (2) to increase or  (2) the button to decrease the desired timer, the “TIMER (min)” windows shows the setting time. Press the timer power button  (4) to start and stop the countdown function. While timer is occurring, the green “TIMER” light will illuminate.

Setting ultrasonic power

1. Press the button  to increase the power setting, on display “POWER” will show 1/2/3/4/5 in loop.

APPLICATION

Airbrushes / spray guns	calligraphy pens / nibs	Dental & surgical instruments
Geological & metallurgical specimens	Inkjet printer cartridges	Laboratory glassware & apparatus
Metal / fibre filters	Microelectronic circuits & component	Nozzles
Production line cleaning	Watches & clockwork	Automotive / Aviation components
Computer plotter pens / nibs	Fuel Injectors	Hypodermic needles
Jewellery	Lenses & other optical components	Metal / rubber seals
Moulding dies	Printed Circuit Boards (PCBs)	Scientific & Industrial instruments



SPECIFICATION

Characteristics	DU-06	DU-32	DU-45	DU-65	DU-100
Capacity (L)	0,6	3,2	4,5	6,5	10
Temperature range (°C)	-	80	80	80	80
Timer (min)	3 - 6	1 - 99	1 - 99	1 - 99	1 - 99
Power control	-	1 - 5	1 - 5	1 - 5	1 - 5
Ultrasonic frequency (kHz)	40	40	40	40	40
Tank size (L x W x H)	150 x 85 x 65	240 x 135 x 100	300 x 150 x 100	300 x 150 x 150	300 x 240 x 150

CLEANING PROCESS

Please observe any national safety regulations that may apply in addition to the present instructions.

Observe the general safety warnings.

The operator is responsible for the control of the cleaning result.

Take the warming of the cleaning liquid into consideration when cleaning temperature-sensitive items.

Ultrasound can damage sensitive surfaces when operated **over a prolonged** period of time and particularly when operated at low cleaning frequencies.

If required for the cleaning operation by hand, pre-heat the liquid (in units of heating).

Immerse the cleaning items into the cleaning liquid. Do not place any items or containers directly onto the tank floor. Use either a cleaning basket, a becker (filled with water + cleaning chemical) or hang the items into the liquid.

Set the cleaning time – switch on the ultrasound.

Monitor the cleaning process: Check the cleaning result by visual inspection. Repeat the cleaning process if necessary.

Rinse the cleaned items after the cleaning and dry if necessary.



MAINTANANCE / CARE

<p>Caution! Pull the mains plug before you carry out any maintenance and care works! Do not put the unit under water! For repair return the unit to your supplier or to the manufacturer.</p>
<p>Electrical safety: Regularly check the housing and the mains cable for damage to avoid electrical accidents.</p>
<p>Care of transducer tank: The deposits in the stainless-steel tank can be removed gently, e.g. by mild decalcifiers. Do not use any scouring media!</p>
<p>Care of housing: Depending on their kind contaminations can be removed with a mild household cleaner or decalcifier (wipe with wet cloth).</p>
<p>Disinfection: If the unit is operated in the medical and sanitary sector it is necessary to disinfect the transducer tank and the surfaces regularly for hygienic purposes (standard surface disinfectants).</p>

DISPOSAL OF ELECTRONIC DEVICES

	<p>The electrical and electronic equipment marked with this symbol cannot be disposed of in public landfills.</p> <p>According to the UE Directive 2002/96/EC, the European users of electrical and electronic equipment can return it to the dealer or manufacturer upon purchase of a new one.</p> <p>The illegal disposal of electrical and electronic equipment is punished with an administrative fine.</p>
--	--



DESCRIPTION DU-06

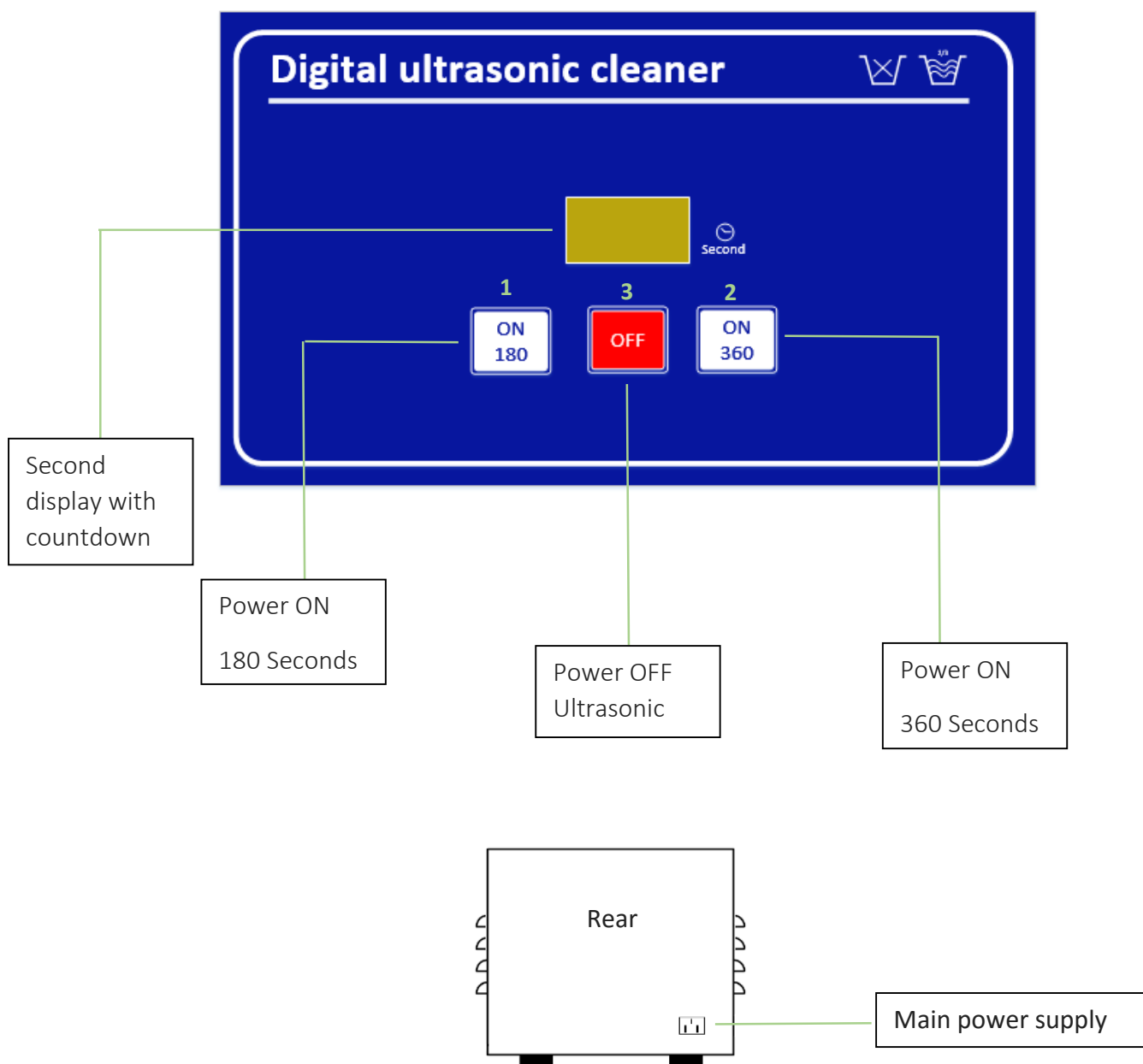

Setting ultrasonic

Press the button  (1) to set 180 Seconds of ultrasonic.

Press the button  (2) to set 360 Seconds of ultrasonic.

Press the button  (3) to stop ultrasonic.

